

- 1 Vorklärung
- 2 Biologie (Picobells)
- 3 Nachklärung
- A Standard-Anschluss:
Zulauf in (1) Ablauf aus (3)
- B Alternative Zulaufmöglichkeiten
- C Alternative Ablaufmöglichkeit

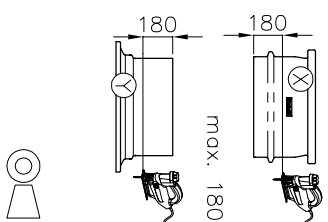
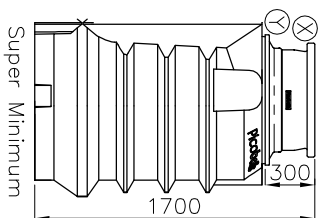
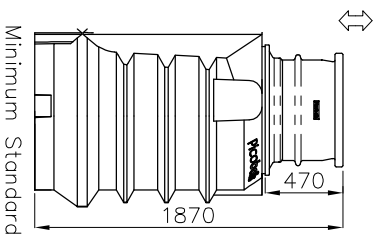
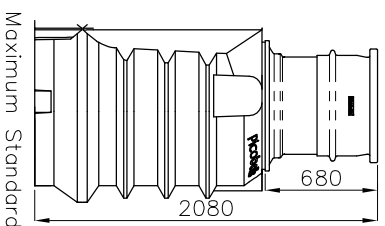
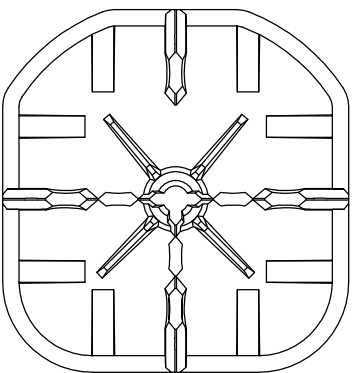
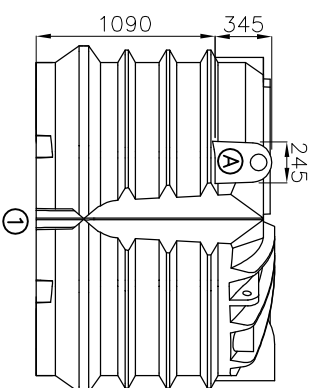
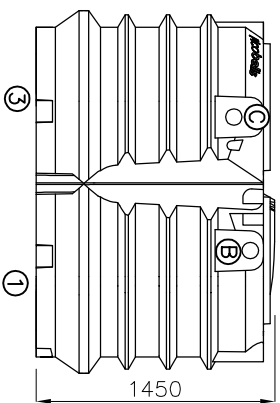
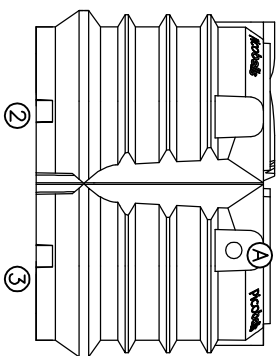
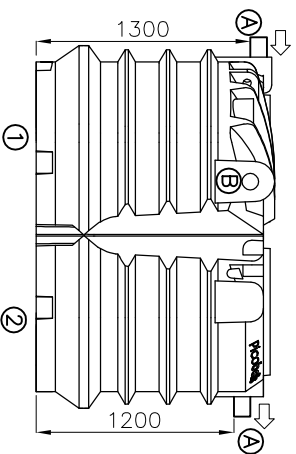

Picobells

Raiffeisenstraße 21
21762 Otterndorf
+49 (0)4751 9785-0

info@picobells.de
www.kleinkloeranlage.com

Picobells 4 – 6 1 170313

Übersicht Overview

17. März 2013

technische Änderungen und Rechte vorbehalten

technical modifications and rights reserved